



SYSTEM MANAGEMENT AMPLIFIER

VM-2120(ER/UK)

DESCRIPTION

The VM-2120 is a multifunctional amplifier that can be mounted in an EIA-Standard equipment rack (3-unit size). The unit comes with 4 audio inputs including the background music input, and the speaker output section which has an internal attenuator and 5-zone selector. It permits not only general-purpose broadcast, but also Emergency Broadcast based on the EN60849 Standard which gives pre-recorded voice instructions(*1) in the emergency situation. Broadcast can be made from an optional RM-200M Remote Microphone as well as from the amplifier, and can be remotely controlled from external equipment. In addition, for 100 V/83 Ω application the unit features the surveillance function(*2) which automatically checks the system for failures.

(*1) An optional EV-200M Voice Announcement Board is required.

(*2) An optional SV-200MA Surveillance Board is required.

SPECIFICATIONS

(*3) 0 dB= 1 V

Power Source	AC: 230 V, 50/60 Hz DC: 24 V/7.5 A, M3.5 screw terminal, Barrier distance: 8 mm (0.31"), Applicable cable diameter: AWG22 - AWG14
Power Consumption on AC Mains	With no signal present: 37 W Under normal operating conditions according to EN60065: 1998 sec. 4.2: 107 W With rated output signal: 201 W
Current Consumption on 24 V DC Power Input	With no signal present: 0.7 A Under normal operating conditions according to EN60065: 1998 sec. 4.2: 2.1 A With rated output signal: 5.2 A
Rated Output	120 W
Output Voltage /Impedance	100 V/83 Ω, 70 V/42 Ω, 50 V/21 Ω (selectable by the internal wiring change)
Frequency Response	50 Hz - 16 kHz
Distortion	1 % or less
Signal-to-Noise Ratio	60 dB or more
Tone Control	Bass: 100 Hz ±10 dB, Treble: 10 kHz ±10 dB (Inputs 1 - 3 and BGM individually adjustable.)
Remote Microphone /Expansion Amplifier Connection	2 RJ45 female connectors for connecting the RM-200M Remote Microphone and the VM-2120 or VM-2240 unit used as an expansion amplifier. Maximum distance: 800 m (874.89 yd) in total Link cable: Category 5 Shielded Number of connectable RM-200M's: Up to 4 Twisted-Pair straight cable (TIA/EIA-568A standard)
Input	Inputs 1 - 3: -60 dB(*3) (MIC)/-10 dB(*3) (LINE) (changeable), 600 Ω, electronically balanced(*4), combined XLR connector (female)/phone jack (Only Input 1 is additionally equipped with DIN connector(*5).) Telephone paging input: Push-in terminal block(*6) Voice sound: -10 dB(*3), 10 kΩ, electronically-balanced input with shield terminal(*4) Control: No-voltage make contact input, open voltage: 3.3 V DC, short-circuit current: under 1 mA BGM 1 - 2: -20 dB(*3), 10 kΩ, RCA pin jack, monaural (internally mixed) Power amplifier input: 0 dB(*3), 10 kΩ, RCA pin jack External speaker line input: 100 V line, for All-Zone Broadcast (This input is selected when the "Unit's broadcast cutoff" control is activated.)
Output	Speaker output: Plug-in screw connector(*7) 5-zone selector with attenuator (all zones simultaneously selectable) Direct speaker line output: Direct output from the power amplifier output transformer (attenuator bypassed), Plug-in screw connector(*7) Line output: 0 dB(*3), 10 kΩ, RCA pin jack Recording output: 0 dB(*3), 10 kΩ, RCA pin jack Preamplifier output: 0 dB(*3), 10 kΩ, RCA pin jack

SPECIFICATIONS

Control Input	For controlling Inputs 1 – 3, Push-in terminal block No-voltage make contact input, open voltage: 3.3 V DC, short-circuit current: 1 mA or less
Control Input and Output	D-sub connector (25-pin, female) Input: No-voltage make contact input, open voltage: 3.3 V DC, short-circuit current: 1 mA or less Output: Open collector output, withstand voltage: 30 V DC, control current: 10 mA or less (1) External control input Activation of messages(*8) Activation of power Activation and stop of Emergency Broadcast Unit's broadcast cutoff (when activated by an external emergency equipment) (2) Status output Irregularity of communications with the Remote Microphone and an expansion amplifier AC power condition DC power condition Irregularity of the sound source of the Voice Announcement Board Failure (FAULT) indication on Power switch on
External Attenuator Control Output	Plug-in screw connector(*7), relay, no-voltage make contact output, transfer type, withstand voltage: 30 V DC, 125 V AC, contact current: 7 A (DC) or less, 7 A (AC) or less
Surveillance Input and Output(*9)	D-sub connector (25-pin, female) Input: No-voltage make contact input, open voltage: 3.3 V DC, short-circuit current: under 1 mA Output: Open collector output, withstand voltage: 30 V DC, control current: 10 mA or less
Power Supply	24 V DC/0.1 A, for supplying power to an optional Amplifier Control Unit RU-2001/-2002, push-in terminal block(*6)
Chime Tone	Built-in chime: 2-tone chime/2-tone chime (fast repeat)/4-tone chime (Up)/Single-tone chime/4-tone chime (Up & Down)/Gong/off Voice Announcement Board sound source: Pre-recorded chime(*8)
Function	Two units stacking (VM-2120 or VM-2240) Emergency broadcast (sequential control) Broadcast priority control Surveillance (failure detection) function(*9) Power supply to only one Remote Microphone (RM-200M) Line resistance: 40 Ω (one way) or less
Operating Temperature	0 °C to +40 °C (32 °F to 104 °F)
Finish	Panel: ABS resin, dark gray (PANTONE 447C or its equivalent), paint Case: Steel plate, dark gray (PANTONE 446C or its equivalent), paint
Dimensions	419 (W) × 143.3 (H) × 355.7 (D) mm (16.5" × 5.64" × 14")
Weight	12.5 kg (27.56 lb)
Accessory	Power cable (2 m (6.56 ft))1, Name label1, Volume cover4, Miniature type time-lag fuse T2.5 A1,
Option	Rack mounting bracket: MB-36 Input transformer: IT-450 Voice announcement board: EV-200M Surveillance board: SV-200MA

(*4) Can be transformer-balanced with the addition of an optional IT-450 input transformer.

(*5) For connection of the Paging Microphone PM-660D with a remote control switch

(*6) Usable cable diameter: AWG26 – AWG20, 0.5 mm²

(*7) Usable cable diameter: AWG24 – AWG12, 2.5 mm²

(*8) An optional EV-200M Voice Announcement Board is required.

The chime sound source must be pre-recorded into a CF (CompactFlash) card to be inserted into the EV-200M Board.

(*9) An optional SV-200MA Surveillance Board is required.

■ APPEARANCE

Magnified view when each optional board is mounted.

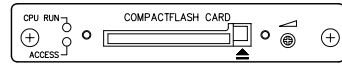
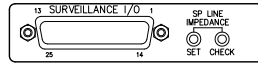

SV-200MA

EV-200M (view with the CF card security cover removed)

Rear View

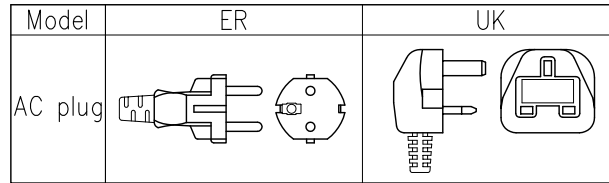
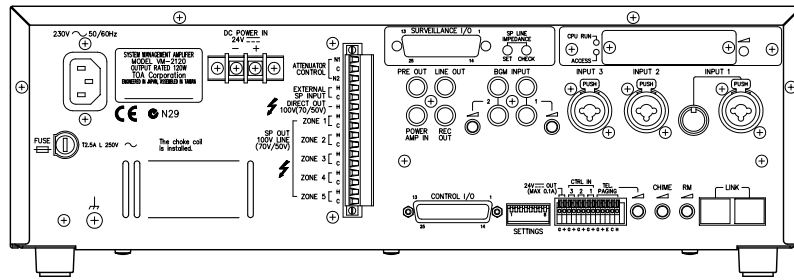

Top View

Rack mounting bracket MB-36 (option)

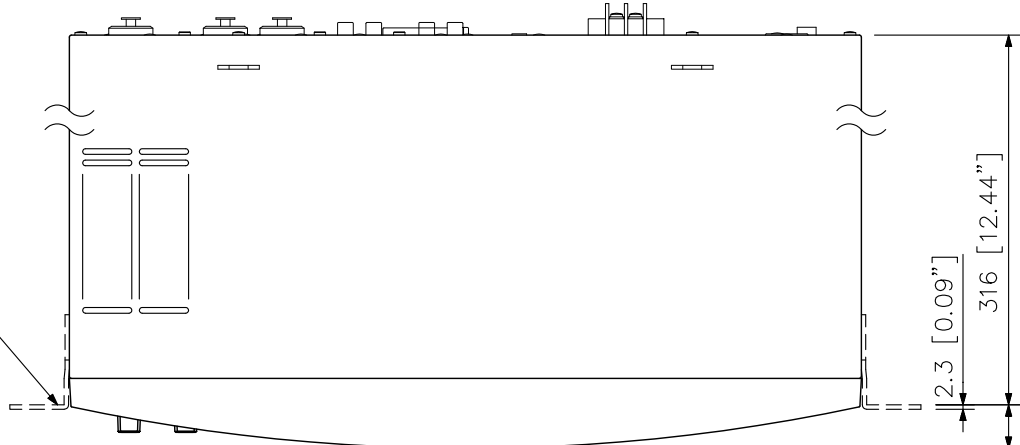

Front View

4-6×10 [0.24"×0.39"]

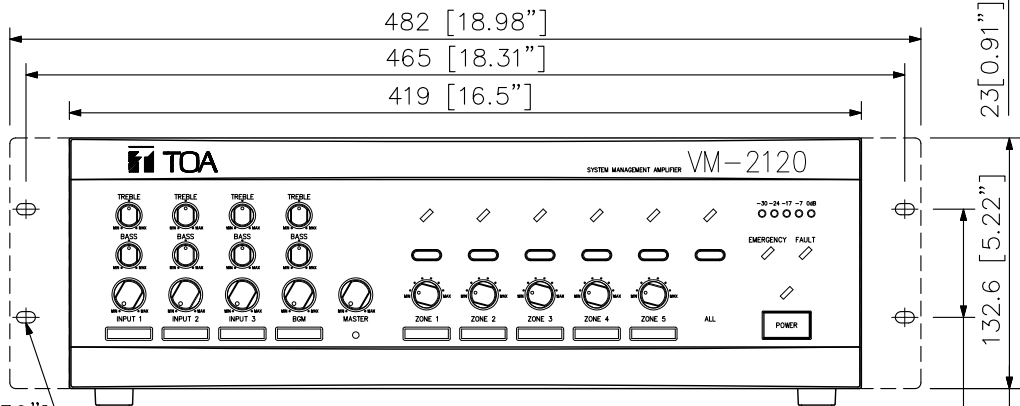

Side View

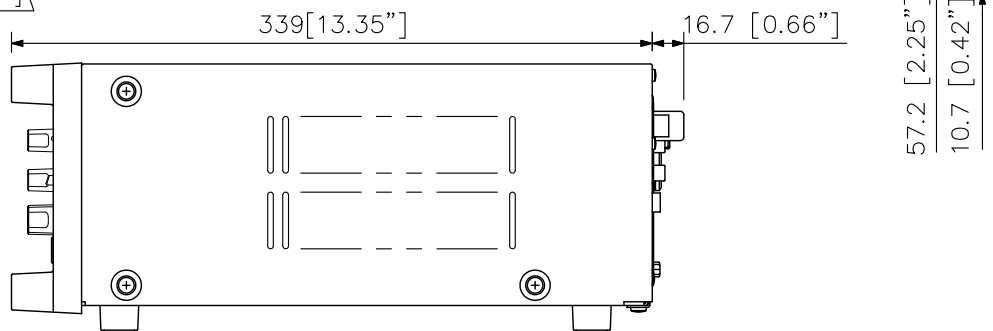

UNIT:mm SCALE:1/4