

Key Features:

- **Dual Horn-Loaded DVX3180 18" LF Transducers with Forced Air Cooling**
- **1000W Continuous (4000W Peak) Power Handling**
- **High-Efficiency Sub-Scoop™ Design**
- **Dual/Parallel Mode Selectable**
- **Very High Sensitivity, 141 dB Maximum SPL**
- **Integral Mounting Points on Rear Panel for Optional Wheel/Caster Kit**
- **Enclosure is Stackable in Both Horizontal and Vertical Orientations**

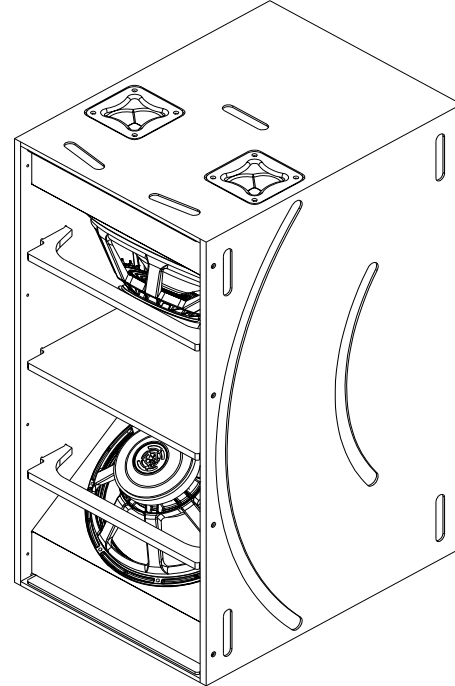

General Description:

The Electro-Voice® PX2181 is a high efficiency dual 18" subwoofer system that is part of the Electro-Voice® Phoenix Series and is intended for high output low frequency sound reinforcement in fixed-installation and portable sound applications. The PX2181 is configured for biamping, and can be used with the PX2122 and PX2152 for full range touring systems with extended LF.

The PX2181 uses dual DVX3180 woofers, a high efficiency 18-inch woofer with forced air cooling. The DVX3180's are coupled to a low frequency horn for maximum efficiency and punch. The enclosure is constructed of 18-mm, 13-ply plywood, using tongue and groove joints and EVCoat for long term durability.

The enclosure is designed to be placed in vertical and horizontal configurations, and alignment cups are placed in the enclosure to array multiple subwoofers. Three PX2122's can be placed on top of the PX2181 in the horizontal configuration. A caster accessory is available on the PX2181 for easy mobility.

A switch on the PX2181 allows connection of both woofers to one amplifier channel in parallel mode, and to be used with each woofer to an amplifier channel in dual mode. In dual mode, three PX2181s can be connected to two amplifier channels for maximum flexibility.

Technical Specifications:

Freq. Response ¹ (-3 dB):	45 Hz - 160 Hz
Freq. Range ¹ (-10 dB):	40 Hz - 180 Hz
Rec. Hipass Frequency:	32 Hz
Axial Sensitivity:	105 dB (1W/1m)
Max Calculated SPL ¹ :	141 dB
Horizontal Coverage:	Omnidirectional
Vertical Coverage:	Omnidirectional
Rated System Power:	1000W Continuous, 4000W Peak
LF Transducers:	(2) DVX3180, 18 in. (457mm) Drivers
Recommended Crossover Frequency:	80 Hz - 125 Hz
Nominal Impedance:	4 Ohms
Connectors:	(2) Neutrik Speakon NL4's
Enclosure Material:	18mm Plywood with Black EVCoat™
Grille:	Polyester Powder Coated, 16GA Galvanized Steel with Rotatable Logo
Dim (H x W x D):	1219mm x 569mm x 758mm (48.00" x 22.42" x 29.85)
Net Weight:	86.5 kg (190.5 lbs)
Shipping Weight:	94.8 kg (208.7 lbs)

¹ Half Space measurement.

Dimension Drawings:

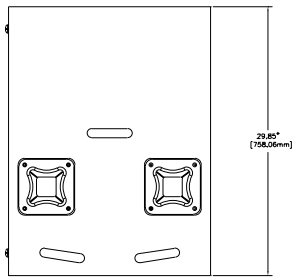

Top View

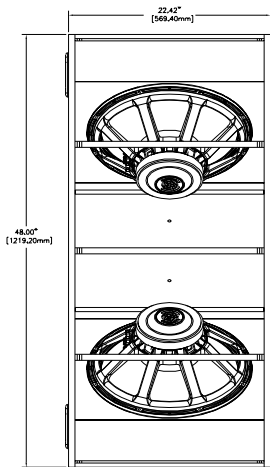

Front View

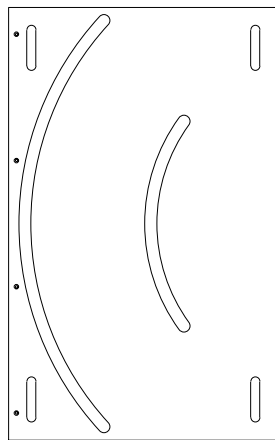

Right View

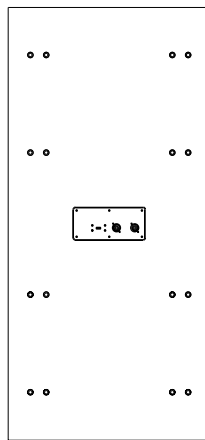

Rear View

Frequency Response:

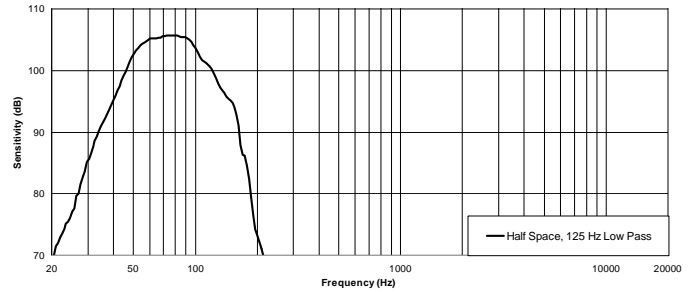

PX2181 Part Number

- 302015-001 PX2181, 18" Subwoofer, Black Finish
- Performance Match**
- 302009-001 PX2122, 30° x 45° Horn, Black Finish
 - 302011-001 PX2152, 60° x 45° Horn, Black Finish
 - 302017-001 PX1122M, 90° x 45° Horn, Black Finish
 - D170401 CP4000S, 120V, 1400W x 2, Compact Precision Series Amplifier
 - D170348 DX38, Digital Loudspeaker Processor

Accessories

- ASY000004-001 PX-D2, Dolly Kit for PX2181

Block Diagram (Parallel Mode):

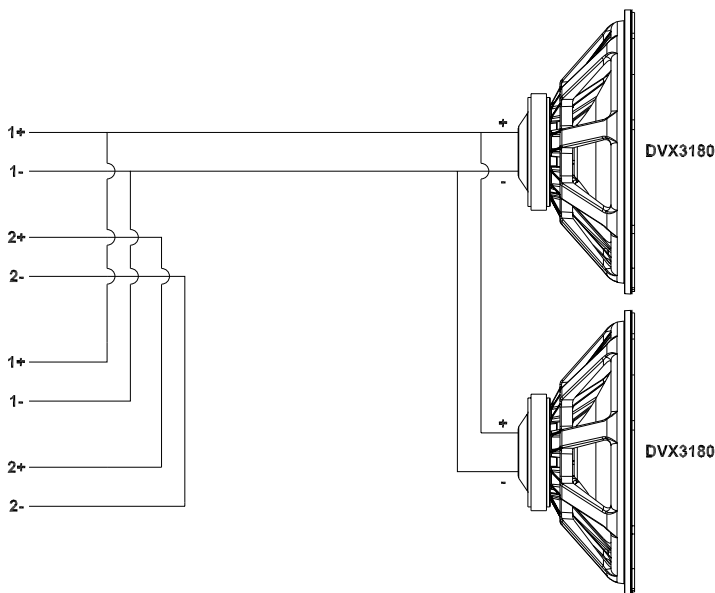

Block Diagram (Dual Mode):

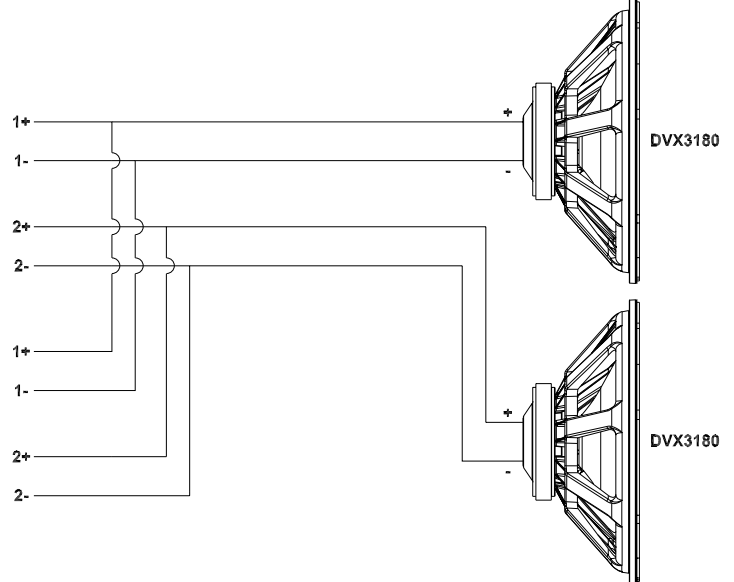

12000 Portland Avenue South, Burnsville, MN 55337

Phone: 952/884-4051, Fax: 952/884-0043

www.electrovoice.com

© Telex Communications, Inc. 6/2006

Part Number 38110-528 Rev. 2

U.S.A. and Canada only. For customer orders, contact Customer Service at:

800/392-3497 Fax: 800/955-6831

Europe, Africa, and Middle East only. For customer orders, contact Customer Service at:

+ 49 9421-706 0 Fax: + 49 9421-706 265

Other International locations. For customer orders, contact Customer Service at:

+ 1 952 884-4051 Fax: + 1 952 736-4212

For warranty repair or service information, contact the Service Repair department at:

800/685-2606

For technical assistance, contact Technical Support at: 866/78AUDIO

Specifications subject to change without notice.